

Cautions, warnings, and regulatory information

READ AND SAVE THESE INSTRUCTIONS Follow the instructions in this installation manual. These instructions must be followed to avoid damage to this product and associated equipment. Product operation and reliability depend upon proper installation.



DO NOT INSTALL ANY AUTOCALL™ PRODUCT THAT APPEARS DAMAGED Upon unpacking your Autocall product, inspect the contents of the carton for shipping damage. If damage is apparent, immediately file a claim with the carrier and notify an authorized Autocall product supplier.



ELECTRICAL HAZARD Disconnect electrical field power when making any internal adjustments or repairs. All repairs should be performed by a representative or an authorized agent of your local Autocall product supplier.



STATIC HAZARD Static electricity can damage components. Handle as follows:

- Ground yourself before opening or installing components.
- Prior to installation, keep components wrapped in anti-static material at all times.



EYE SAFETY HAZARD Under certain fiber optic application conditions, the optical output of this device may exceed eye safety limits. Do not use magnification (such as a microscope or other focusing equipment) when viewing the output of this device.



SULFURIC ACID WARNING Battery contains sulfuric acid, which can cause severe burns to the skin and eyes and can destroy fabric. Replace any leaking or damaged battery while wearing appropriate protective gear. If you come in contact with sulfuric acid, immediately flush skin or eyes with water for 15 minutes and seek immediate medical attention.

FCC RULES AND REGULATIONS – PART 15 This equipment has been tested and found to comply with the limits for a Class A digital device, pursuant to Part 15 of the FCC Rules. These limits are designed to provide reasonable protection against harmful interference when the equipment is operated in a commercial environment. This equipment generates, uses, and can radiate radio frequency energy and, if not installed and used in accordance with the instruction manual, may cause harmful interference to radio communications. Operation of this equipment in a residential area is likely to cause harmful interference in which case the user will be required to correct the interference at his own expense.

SYSTEM REACCEPTANCE TEST AFTER SOFTWARE CHANGES To ensure proper system operation, this product must be tested in accordance with NFPA-72, after any programming operation or change in site-specific software. Reacceptance testing is required after any change, addition or deletion of system components, or after any modification, repair or adjustment to system hardware or wiring. All components, circuits, system operations, or software functions known to be affected by a change must be 100% tested. In addition, to ensure that other operations are not inadvertently affected, at least 10% of initiating devices that are not directly affected by the change, up to a maximum of 50 devices, must also be tested and proper system operation verified.

NFPA 72® is a registered trademark of the National Fire Protection Association.

Introduction

The IDNet 2* card provides the Fire Alarm Control Panel (FACP) with one isolated IDNet Signaling Line Circuit (SLC) (or channel) and with up to four isolated loop outputs. This card is used with compatible** IDNet communicating devices and allows the system CPU to communicate with up to 250 initiating devices, such as smoke sensors and pull stations. Isolated IDNet communications provide overall operation improvement, and isolated output loops allow a short circuit on one loop to avoid impacting the other loops.

There are two available configurations for the IDNet 2 card:

- **A100-3109 IDNet 2 card:** This is the basic configuration which provides the FACP with two Class B / DCLB (or Class A / DCLA or Class X / DCLC) loop outputs that are isolated from each other as well.
- **A100-3110 IDNet 2+2 card:** In this configuration, the A100-3109 IDNet 2 card is fitted with two A100-3111 IDNet Loop cards and provides the FACP with four Class B / DCLB (or Class A / DCLA or Class X / DCLC) isolated IDNet loops. Two isolated loops are provided by the card and one isolated loop is added per IDNet Loop card.

*= Unless specified otherwise, the term "IDNet 2" is used in this manual to designate both the IDNet 2 and the IDNet 2+2 cards.

Note: The A100-3111 IDNet Loop daughter card can be purchased separately and placed on a pre-installed IDNet 2 card that is not EPS-mounted. However, once it is added to the IDNet card, the compatibility and programming requirements will become the same as with the IDNet 2+2 card.

Important: Verify FACP system programmer, executive, and slave software compatibility when installing, or replacing system components. Refer to the Technical Support Information and Downloads website for compatibility information.

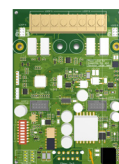

IDNet 2 Card

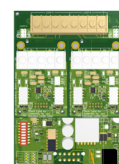

IDNet 2+2 Card



IDNet Loop Card



Card Layout

Compatibility

Hardware compatibility:

IDNet 2: 4100ES bays, EPS modules, 4100U bays.

IDNet 2+2: 4100ES bays, 4100U bays, ES-PS modules.

Software compatibility:

For use with revision 2.04 or higher of the ES Panel Programmer Software, and revision 12.08 of the 4100U Programmer and Master software.

Card Layout

The IDNet 2 is a standard 4x5 card that can accommodate two IDNet Loop cards. Figure 1 highlights the feature elements of these cards.

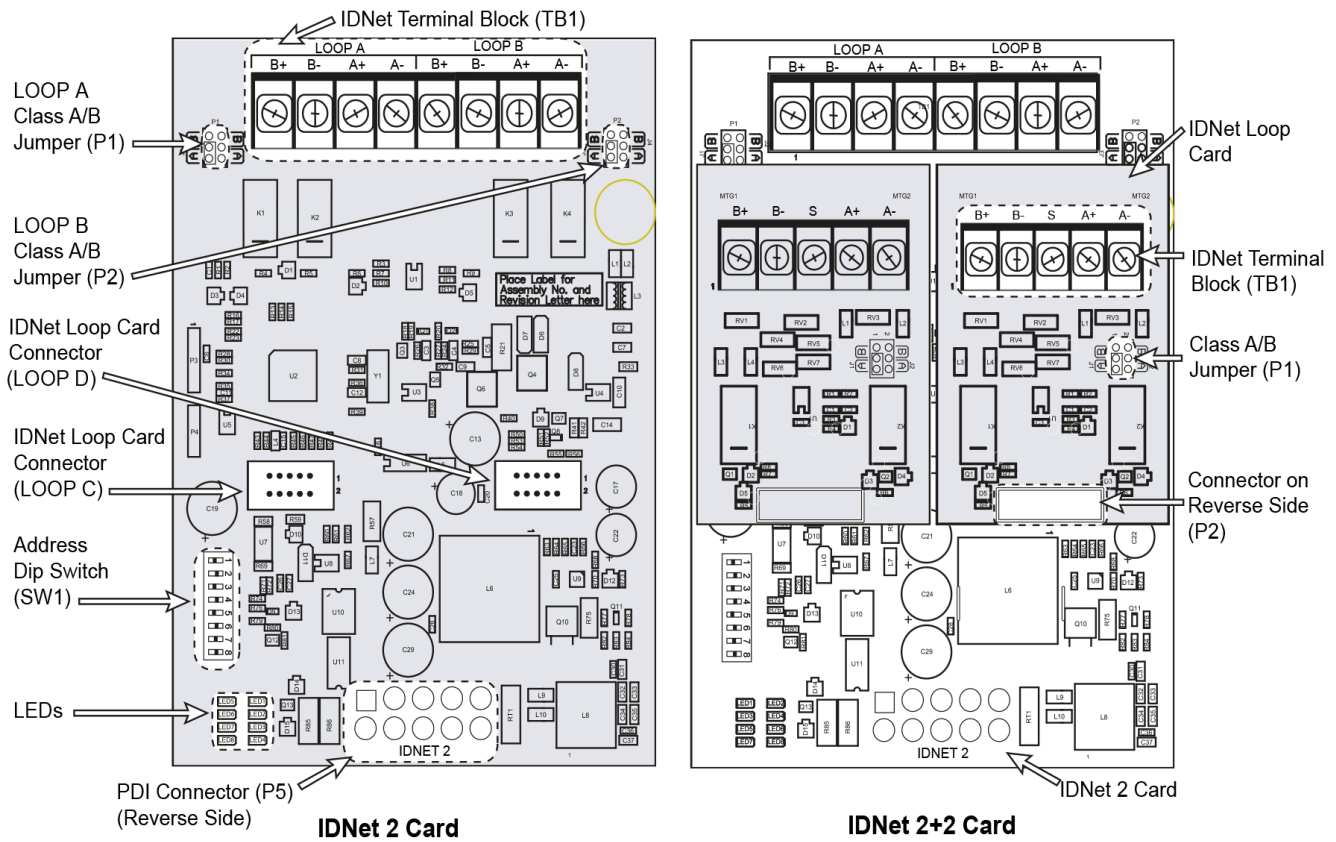
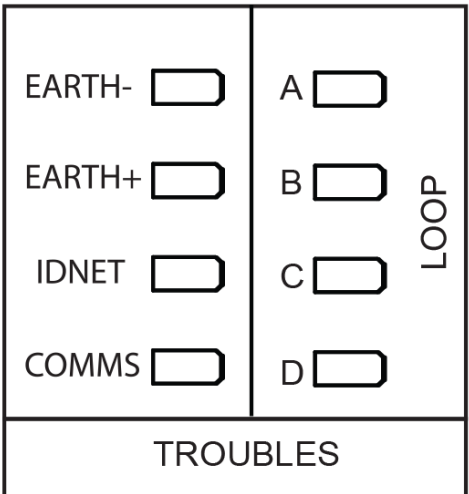

Figure 1: Card Layout

LED Identification

The IDNet 2 Card is equipped with 8 LEDs that report the card troubles. Table 1 identifies and describes the different LEDs.

Table 1: LED Definition

LED Name	LED description	LED Map
Loop A	When a trouble occurs on a loop, the LED corresponding to that loop illuminates.	
Loop B		
Loop C		
Loop D		
Earth-	Normally Off. Illuminates to indicate a negative earth fault.	
Earth+	Normally Off. Illuminates to indicate a positive earth fault.	
IDNet	Normally off. Illuminates to indicate a problem with the IDNet channel: <ul style="list-style-type: none"> Steady on indicates channel failure. 	
Comms	Normally off. Turns on steady if the card is not communicating with the FACP CPU.	

Setting the Address

The DIP Switch SW1 is used to set the IDNet 2 card address as identified in the Panel Programmer job (see the section on Programming for more information). From left to right, these switches are designated as SW1-1 through SW1-8. The function of these switches is as follows:

- **SW1-1.** This switch sets the baud rate for the internal communications line running between the card and the CPU. Set this switch to ON.
- **SW1-2 through SW1-8.** These switches set the card's address within the FACP. Refer to Figure 3 for a complete list of the switch settings for all of the possible card addresses.

You must set these switches to the value assigned to the card by the Panel Programmer.

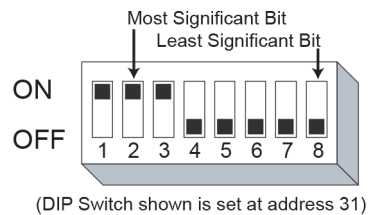

Figure 2: DIP Switch SW1

Address	SW 1-2	SW 1-3	SW 1-4	SW 1-5	SW 1-6	SW 1-7	SW 1-8	Address	SW 1-2	SW 1-3	SW 1-4	SW 1-5	SW 1-6	SW 1-7	SW 1-8
1	ON	N O	ON	N O	ON	ON	OFF	81	ON	OFF	OFF	OFF	OFF	ON	OFF
2	ON	ON	ON	ON	ON	OFF	ON	82	ON	OFF	OFF	OFF	OFF	OFF	ON
3	ON	N O	ON	N O	ON	OFF	OFF	83	ON	OFF	OFF	OFF	OFF	OFF	OFF
4	ON	ON	ON	ON	OFF	ON	ON	84	OFF	ON	ON	ON	ON	ON	ON
5	ON	N O	ON	N O	OFF	ON	OFF	85	OFF	ON	ON	N O	N O	ON	OFF
6	ON	ON	ON	ON	OFF	OFF	ON	86	OFF	ON	ON	ON	ON	OFF	ON
7	ON	N O	ON	N O	OFF	OFF	OFF	87	OFF	ON	ON	N O	N O	OFF	OFF
8	ON	ON	ON	OFF	ON	ON	ON	88	OFF	ON	ON	ON	OFF	ON	ON
9	ON	ON	ON	OFF	ON	ON	OFF	89	OFF	ON	ON	ON	OFF	ON	OFF
10	ON	ON	ON	OFF	ON	OFF	ON	90	OFF	ON	ON	ON	OFF	OFF	ON
11	ON	ON	ON	OFF	ON	OFF	OFF	91	OFF	ON	ON	ON	OFF	OFF	OFF
12	ON	ON	ON	OFF	OFF	ON	ON	92	OFF	ON	ON	OFF	ON	ON	ON
13	ON	ON	ON	OFF	OFF	ON	OFF	93	OFF	ON	ON	OFF	ON	ON	OFF
14	ON	ON	ON	OFF	OFF	OFF	ON	94	OFF	ON	ON	OFF	ON	OFF	ON
15	ON	ON	ON	OFF	OFF	OFF	OFF	95	OFF	ON	ON	OFF	ON	OFF	OFF
16	ON	ON	OFF	ON	ON	ON	ON	96	OFF	ON	ON	OFF	ON	ON	ON
17	ON	ON	OFF	ON	ON	ON	OFF	97	OFF	ON	ON	OFF	ON	ON	ON
18	ON	ON	OFF	ON	ON	OFF	ON	98	OFF	ON	ON	OFF	ON	ON	ON
19	ON	ON	OFF	ON	ON	OFF	OFF	99	OFF	ON	ON	OFF	ON	OFF	OFF
20	ON	ON	OFF	ON	OFF	ON	ON	100	OFF	ON	ON	OFF	ON	ON	ON
21	ON	ON	OFF	ON	OFF	ON	OFF	101	OFF	ON	ON	OFF	ON	ON	OFF
22	ON	ON	OFF	ON	OFF	OFF	ON	102	OFF	ON	ON	OFF	ON	OFF	ON
23	ON	ON	OFF	ON	OFF	OFF	OFF	103	OFF	ON	ON	OFF	ON	OFF	OFF
24	ON	ON	OFF	OFF	ON	ON	ON	104	OFF	ON	ON	OFF	ON	ON	ON
25	ON	ON	OFF	OFF	ON	ON	OFF	105	OFF	ON	ON	OFF	ON	ON	OFF
26	ON	ON	OFF	OFF	ON	OFF	ON	106	OFF	ON	ON	OFF	ON	OFF	ON
27	ON	ON	OFF	OFF	ON	OFF	OFF	107	OFF	ON	ON	OFF	ON	OFF	OFF
28	ON	ON	OFF	OFF	OFF	ON	ON	108	OFF	ON	ON	OFF	ON	ON	ON
29	ON	ON	OFF	OFF	OFF	ON	OFF	109	OFF	ON	ON	OFF	ON	ON	OFF
30	ON	ON	OFF	OFF	OFF	OFF	ON	110	OFF	ON	ON	OFF	ON	OFF	ON
31	ON	ON	OFF	OFF	OFF	OFF	OFF	111	OFF	ON	ON	OFF	ON	OFF	OFF
32	ON	OFF	ON	ON	ON	ON	ON	112	OFF	ON	ON	OFF	ON	ON	ON
33	ON	OFF	ON	ON	ON	ON	OFF	113	OFF	ON	ON	OFF	N O	N O	ON
34	ON	OFF	ON	ON	ON	OFF	ON	114	OFF	ON	ON	OFF	ON	ON	OFF
35	ON	OFF	ON	ON	ON	OFF	OFF	115	OFF	ON	ON	OFF	N O	N O	OFF
36	ON	OFF	ON	ON	OFF	ON	ON	116	OFF	ON	ON	OFF	ON	ON	ON
37	ON	OFF	ON	ON	OFF	ON	OFF	117	OFF	ON	ON	OFF	ON	ON	OFF
38	ON	OFF	ON	ON	OFF	OFF	ON	118	OFF	ON	ON	OFF	ON	OFF	ON
39	ON	OFF	ON	ON	OFF	OFF	OFF	119	OFF	ON	ON	OFF	ON	OFF	OFF
40	ON	OFF	ON	OFF	ON	ON	ON								
41	ON	OFF	ON	OFF	ON	ON	OFF								
42	ON	OFF	ON	OFF	ON	OFF	ON								
43	ON	OFF	ON	OFF	ON	OFF	OFF								
44	ON	OFF	ON	OFF	OFF	ON	ON								
45	ON	OFF	ON	OFF	OFF	ON	OFF								
46	ON	OFF	ON	OFF	OFF	OFF	ON								
47	ON	OFF	ON	OFF	OFF	OFF	OFF								
48	ON	OFF	OFF	ON	ON	ON	ON								
49	ON	OFF	OFF	ON	ON	ON	OFF								
50	ON	OFF	OFF	ON	ON	OFF	ON								
51	ON	OFF	OFF	ON	ON	OFF	OFF								
52	ON	OFF	OFF	ON	OFF	ON	ON								
53	ON	OFF	OFF	ON	OFF	ON	OFF								
54	ON	OFF	OFF	ON	OFF	OFF	ON								
55	ON	OFF	OFF	ON	OFF	OFF	OFF								
56	ON	OFF	OFF	OFF	ON	ON	ON								
57	ON	OFF	OFF	OFF	ON	ON	OFF								
58	ON	OFF	OFF	OFF	ON	OFF	ON								
59	ON	OFF	OFF	OFF	ON	OFF	OFF								
60	ON	OFF	OFF	OFF	OFF	ON	ON								

Figure 3: A100-3109 IDNet 2 Card Addresses

Installation

Mounting

The IDNet 2 card and the IDNet 2+2 card mount onto the Power Distribution Interface (PDI) in a FACP expansion cabinet. The IDNet 2 card can also be installed in the expansion slot of an ES Power Supply Card (ES-PS) card.

To mount the IDNet 2 and IDNet 2+2 card:

1. Select an empty PDI connector. Insert the washer and the metal standoffs into the corresponding installation holes.
2. Insert the PDI connector on the back of the card into the PDI connector.
3. Use the provided hardware to secure the card.

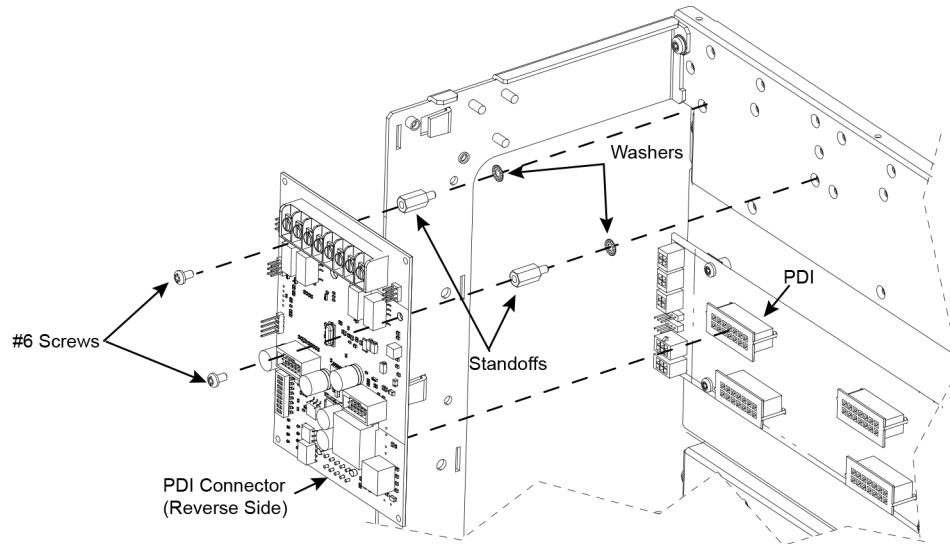

Figure 4: Mounting an IDNet 2 or IDNet 2+2 card (IDNet 2 card shown)

To add IDNet Loop cards to an IDNet 2 card:

1. Remove the screws that attach the IDNet 2 card to the panel.
2. Insert the metal standoffs and the plastic standoffs into the corresponding installation holes.
3. Insert the connector on the back of the IDNet Loop card into the connector on the IDNet 2 card and snap it in place with the plastic standoff.
4. Use the provided hardware to secure the card.

Note: When adding IDNet Loop cards to a pre-installed IDNet 2 card, it is important to remember that the properties of the IDNet 2 card must be updated in the FACP programmer.

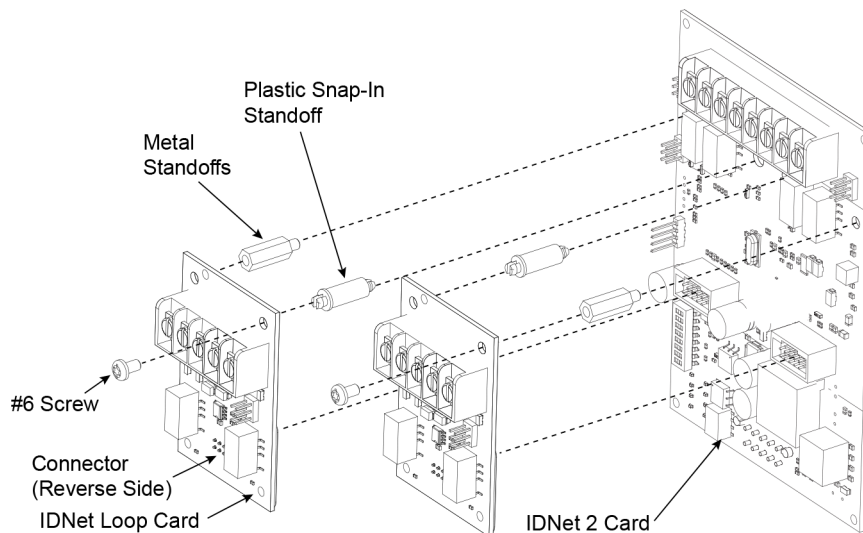

Figure 5: Adding an IDNet Loop Card to an IDNet 2 Card

Wiring Overview

Each IDNet output from the IDNet 2+2 card can be wired as either an isolated Class A / DCLA circuit, a Class X / DCLC circuit, or as two isolated Class B / DCLB circuits.

Class A / DCLA wiring provides an alternate communication path that allows communication to all devices to be maintained when a single open circuit fault occurs. Class A wiring requires two wires to be routed from the Primary Terminals (B+, B-) to each device, and then back to the Secondary Terminals (A+, A-). Wiring is in/out, "T" tapping is not allowed.

Class B / DCLB wiring allows "T" tapping. IDNet wiring is inherently supervised due to individual device level communications. End-of-line resistors are not required.

Class X / DCLC wiring improves on Class A wiring by providing resilience not only to single open fault but also to a single short-circuit fault. Use IDNet Isolator or Isolator2 devices.

Ferrite Beads

You must use ferrite beads for field wiring. To install ferrite beads, complete the following steps:

1. Install a ferrite bead near any IDNet field wiring terminals in use (terminals B+/B- or terminals A+/A-) for the lowest radiated emissions. Install the ferrite bead at a place before the wires leave the enclosure.
2. Loop the wires through the bead as shown in Figure 6.

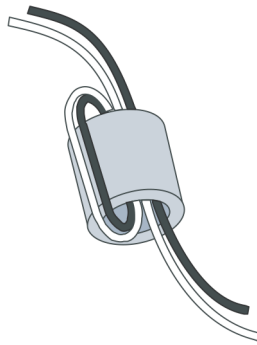

Figure 6: Ferrite bead installation

Wiring Parameters

Table 2 identifies the card wiring parameters that must be considered when installing these cards.

Table 2: Card Wiring Parameters

Wiring Capacitance Parameters				
Parameter	Value			
Maximum Supported Channel Capacitance; Total of all four Isolated Outputs.	The sum of line-to-line capacitance, plus the capacitance of either line-to-shield (if shield is present) = 0.6 μ F (600 nF).			
Capacitance between IDNet SLC wiring (between wires of the same polarity; plus to plus, minus to minus).	1 μ F maximum (this is for multiple IDNet loops).			
Wiring Distance Limits (see note below).				
Channel Loading	Class B Wiring, Total Channel Wiring Parameters, Including T-Taps		Class A or X Wiring, Total Channel Wiring Parameters	
	Up to 125 devices	126 to 250 devices	Up to 125 devices	126 to 250 devices
Total Loop Resistance	50 Ω maximum	35 Ω maximum	50 Ω maximum	35 Ω maximum
18 AWG (0.82 mm ²)	4000 ft (1219 m) per run, 12,500 ft (3810 m) total	2500 ft (762 m) per run, 10,000 ft (3048 m) total	4000 ft (1219 m) per loop, 12,500 ft (3810 m) total	2500 ft (762 m) per loop, 10,000 ft (3048 m) total
16 AWG (1.31 mm ²)	5000 ft (1524 m) per run, 12,500 ft (3810 m) total	2500 ft (762 m) per run, 10,000 ft (3048 m) total	5000 ft (1524 m) per loop, 12,500 ft (3810 m) total	2500 ft (762 m) per loop, 10,000 ft (3048 m) total
14 AWG (2.08 mm ²)				
12 AWG (3.31 mm ²)				
Note: Maximum wiring distance is determined by either reaching the maximum resistance, the maximum capacitance, or the stated maximum distance, whichever occurs first. Class A or X maximum distances are to the farthest device on the loop from either "B" or "A" terminals. For Class B wiring, the maximum distance to the farthest device is limited to the stated Class A or X wiring distances.				
Wiring Considerations using A2081-9044 Overvoltage Protectors. (A2081-9044 is UL listed to Standard 1459, Standard for Telephone Equipment).	Note: External wiring must be shielded (for lightning suppression) and A2081-9044 Overvoltage Protectors must be installed at building exit and entrance locations.			
	Capacitance: Each protector adds 0.006 μ F across the connected line.			
	Resistance: Each protector adds 3 Ω per line of series resistance; both IDNet lines are protected; 6 Ω per protector will be added to total loop resistance.			
	Maximum distance of a single protected wiring run is 3270 ft (1 km). Refer to document number 574-832AC: <i>A2081-9044 Overvoltage Protector Installation Instructions</i> for additional information.			

Class A / DCLA Wiring

To wire the Loop terminals as a Class A circuit:

1. Set the jumper assigned to the loop to the "A" position, as shown in Figure 7.
 - Loop A= Jumper P1 on the IDNet 2 card
 - Loop B= Jumper P2 on the IDNet 2 card
 - Loop C= Jumper P1 on the first IDNet Loop cards
 - Loop D= Jumper P1 on the second IDNet Loop card
2. Shielded wire is not recommended. If shielded wires are present, cut and tape off the shield to prevent it from coming in contact with other components. Metallic continuity of the shield must be maintained and insulated throughout the entire length of the cable.
3. Route the wiring from the Primary Terminals (B+, B-) to the corresponding inputs on the first device.
4. Route wiring from the first device to the next as in/out. See Figure 8. Repeat for each device.
5. Route the wiring from the last device to the panel.
6. Connect the wiring to the corresponding Secondary Terminals (A+, A-).

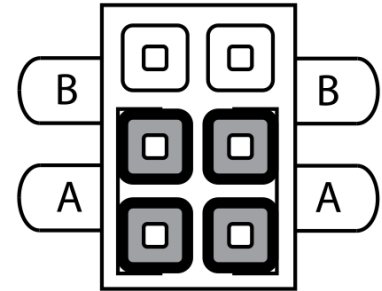

Figure 7: Class A Jumper Setting

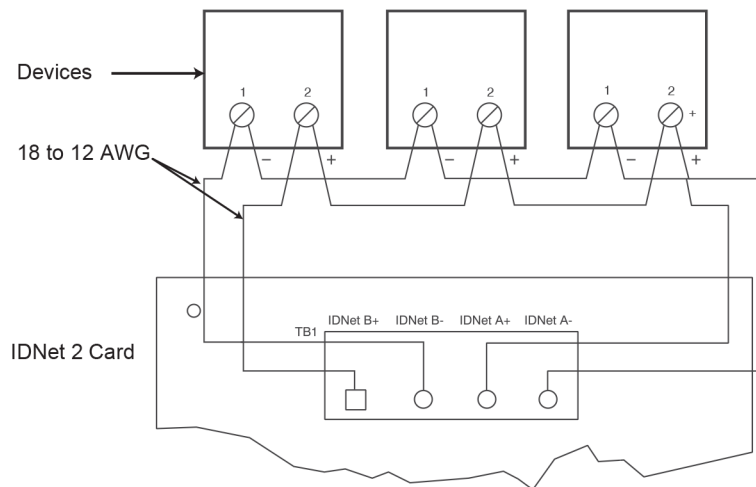

Figure 8: IDNet Loop Class A Wiring

Class A wiring notes:

- If no remote isolators or isolator bases are on the loops, you can assign device addresses in any sequence.
- If remote isolators (A4090-9116, A4090-9122) or isolator bases (A4098-9766, A4098-9767, A4098-9777, A4098-9793) are on the loops, it is recommended to address the isolators in ascending order: start from the "B" side and assign each successive isolator a higher address than the isolator it precedes. Isolation functionality is not affected by the order of isolator addresses.
- If there are any remote isolators (A4090-9116) or isolator bases (A4098-9777, A4098-9793) on the channel, addressing the isolators as recommended speeds up the system power up.
- If there are only isolator2 (A4090-9122) or isolator2 bases (A4098-9766, A4098-9767) on the channel, addressing the isolators as recommended speeds up the Earth Fault Search diagnostic tool.
- Regular IDNet devices (that are not isolators A4090-9116, A4090-9122, A4098-9777, A4098-9793, A4098-9766, A4098-9767) can be addressed in any way without impact.

Class B / DCLB Wiring

When wiring the loop for Class B circuits, both the B+, B- and A+, A- terminals are available for parallel connections. Within the IDNet circuitry, A+ is connected to B+, and A- is connected to B- so circuits can stem from either one. Additionally, two wires can be connected to each screw terminal.

To wire the Loop terminals as a Class B circuit:

- Set the jumper assigned to the loop to the "B" position, as shown in Figure 9.
 - Loop 1 = Jumper P1 on the IDNet 2 card
 - Loop 2 = Jumper P2 on the IDNet 2 card
 - Loop 3 = Jumper P1 on the left IDNet Loop card
 - Loop 4 = Jumper P1 on the right IDNet Loop card
- Route wiring from the Primary Terminals (B+, B-) to the corresponding inputs on the first device. It is possible to add up to 4 circuits per IDNet loop on the terminal block when using Class B wiring. See Figure 10 for the diagram.
- Route wiring from the first device to the next as in/out as shown in Figure 10. Repeat for each device.
- Shielded wire is not recommended. If shielded wires are present, cut and tape off the shield at each end (in the panel and at the last device in each run) to prevent it from coming in contact with other components. Metallic continuity of the shield must be maintained and insulated throughout the entire length of the cable.

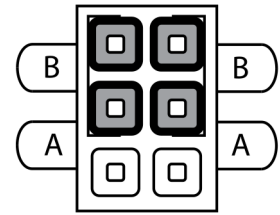

Figure 9: Class B Jumper Setting

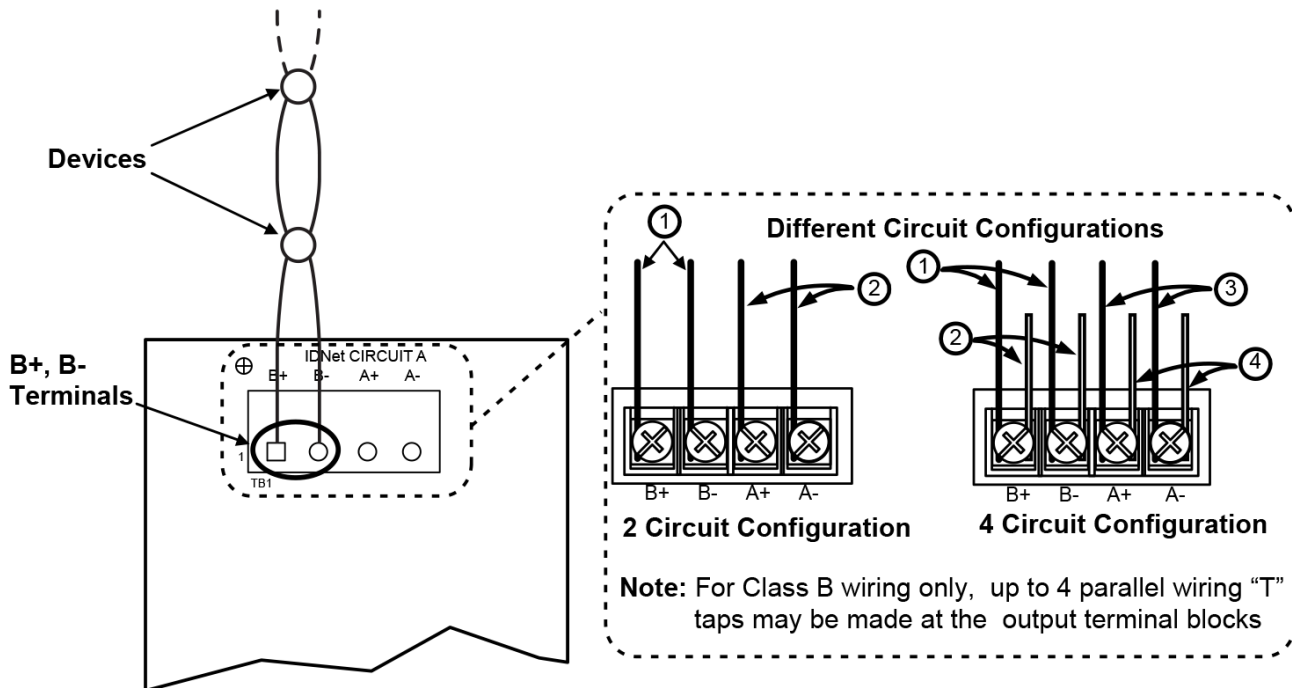

Figure 10: IDNet Loop Class B Wiring

Class B wiring Notes:

- If no remote isolators or isolator bases are on the loops, you can assign device addresses in any sequence.
- If remote isolators (A4090-9116, A4090-9122) or isolator bases (A4098-9766, A4098-9767, A4098-9777, A4098-9793) are on the loops, it is recommended to address the isolators in ascending order: start at the output and assign each successive isolator a higher address than the isolator it precedes. For Class B wiring only, the "A" output and "B" output per loop are connected together in parallel for wiring convenience. Isolation functionality is not affected by the order of isolator addresses.
- If there are any remote isolators (A4090-9116) or isolator bases (A4098-9777, A4098-9793) on the channel, addressing the isolators as recommended speeds up the system power up.
- If there are only isolator2 (A4090-9122) or isolator2 bases (A4098-9766, A4098-9767) on the channel, addressing the isolators as recommended speeds up the Earth Fault Search diagnostic tool.
- Regular IDNet devices (that are not isolators A4090-9116, A4090-9122, A4098-9777, A4098-9793, A4098-9766, A4098-9767) can be addressed in any way without impact.

Class X / DCLC Wiring

To wire the loop terminals as a Class X circuit, follow [Class A / DCLA Wiring](#) guidelines and insert IDNet Isolator or Isolator2 devices along the loop.

Programming

Adding the IDNet 2 to the Programmer

The IDNet 2 card must be added to the FACP through the ES Panel Programmer.

Note:

The IDNet 2+2 card can be added to the programmer using the same steps as shown below. The difference is in selecting the A100-3110/A100-3112 IDNet 2+2 card from the Available Hardware window instead of the A100-3109 IDNet 2 card.

Note: To add the IDNet 2 card to the programmer:

1. Start the programmer software.
2. Open an existing job or create a new one.
3. Select the **Hardware** tab.
4. Open the Box and the Bay in which you want to place the card.
5. Select the A100-3109 IDNet 2 card from the Available Hardware window under the "Interface" menu and drag it to the bay. The card has now been added to your FACP.
6. Double click on the card's icon to access the **Card Properties**, **Point Editing** and **Loop Editing** tabs. See the "Configuring the Card Properties Tab" section for more information.

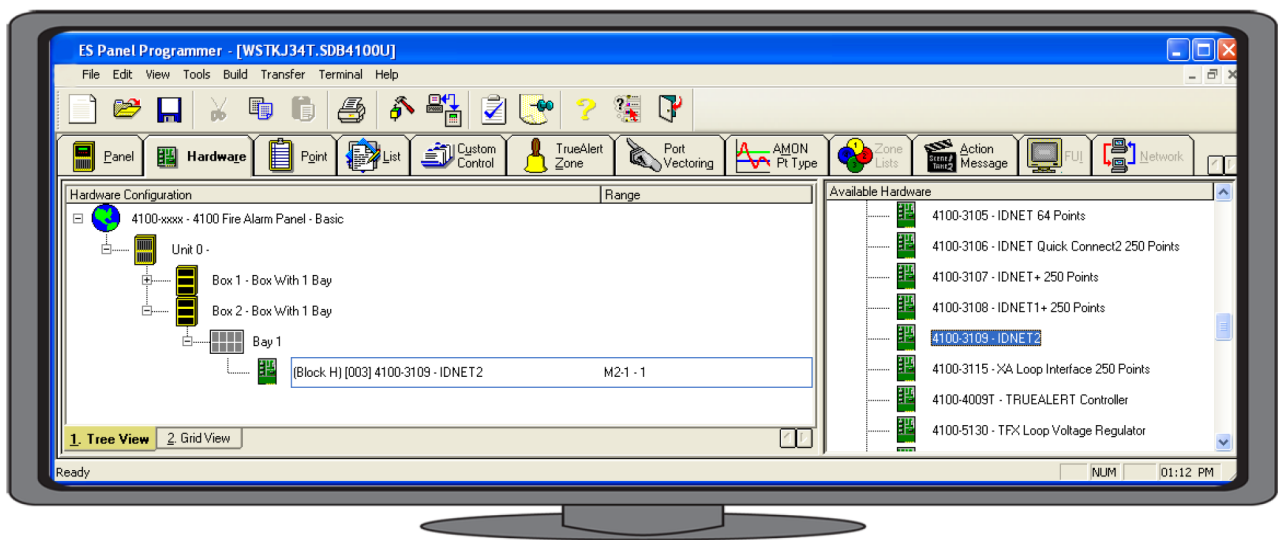

Figure 11: Adding the IDNet 2 Card to the FACP

Configuring the Card Properties Tab

The first tab that require configuring is the Card Properties tab.

To configure the Car Properties tab enter the following information:

- **Card Address.***
- **Card Description.**
- **Card Default label.**
- **Card Custom Label:** This field can be used to describe the card's function, location, or other descriptive information.
- **Card Alternate Custom Label:** This field is used to have an alternative description of the card.
- **Annunciator:** This field indicates which annunciator the card is associated with.
- **Number of units, bays, and boxes.***
- **Location.***
- **Only activate TrueAlarm device LEDs**:** Select this option to only activate the LEDs corresponding to TrueAlarm devices in a state of alarm (up to 20 devices at any given time).
- **Activate Signal IAM LEDs**:** Select this option to only activate the LEDs corresponding to Signal IAM devices that are in a state of alarm (up to 20 devices at any given time).
- **24 V Alarm and Standby current (Amps).**

* It is possible to modify the default data manually, however, an error will be triggered if the information entered does not correspond with the FACP data.

** These options are independent of each other, either one or both can be selected.

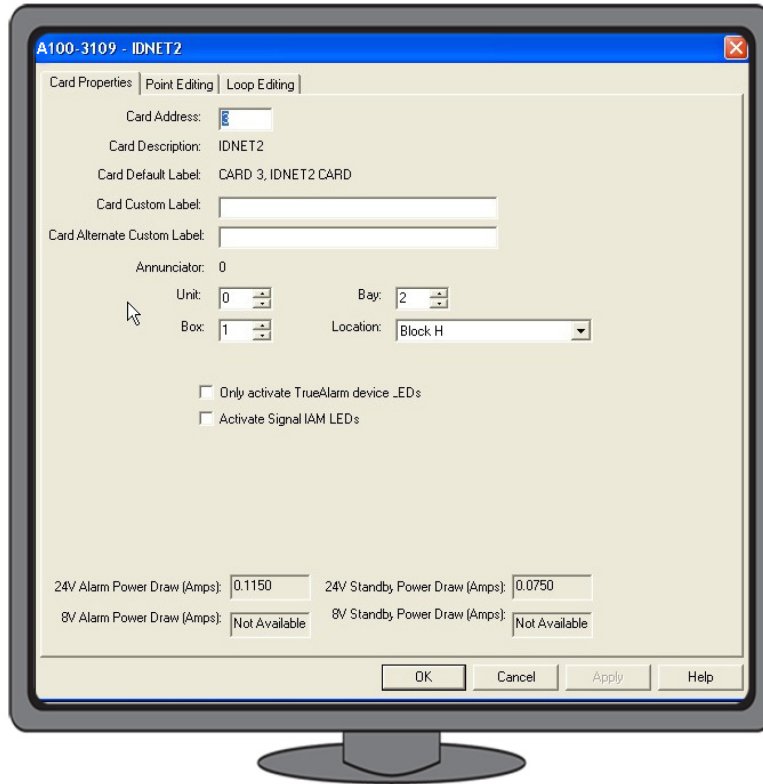

Figure 12: Card Properties Tab

Configuring the Point Editing Tab

The next tab is the Point Editing tab. This tab is used to manage and edit the point types that correspond to the devices on the IDNet loop.

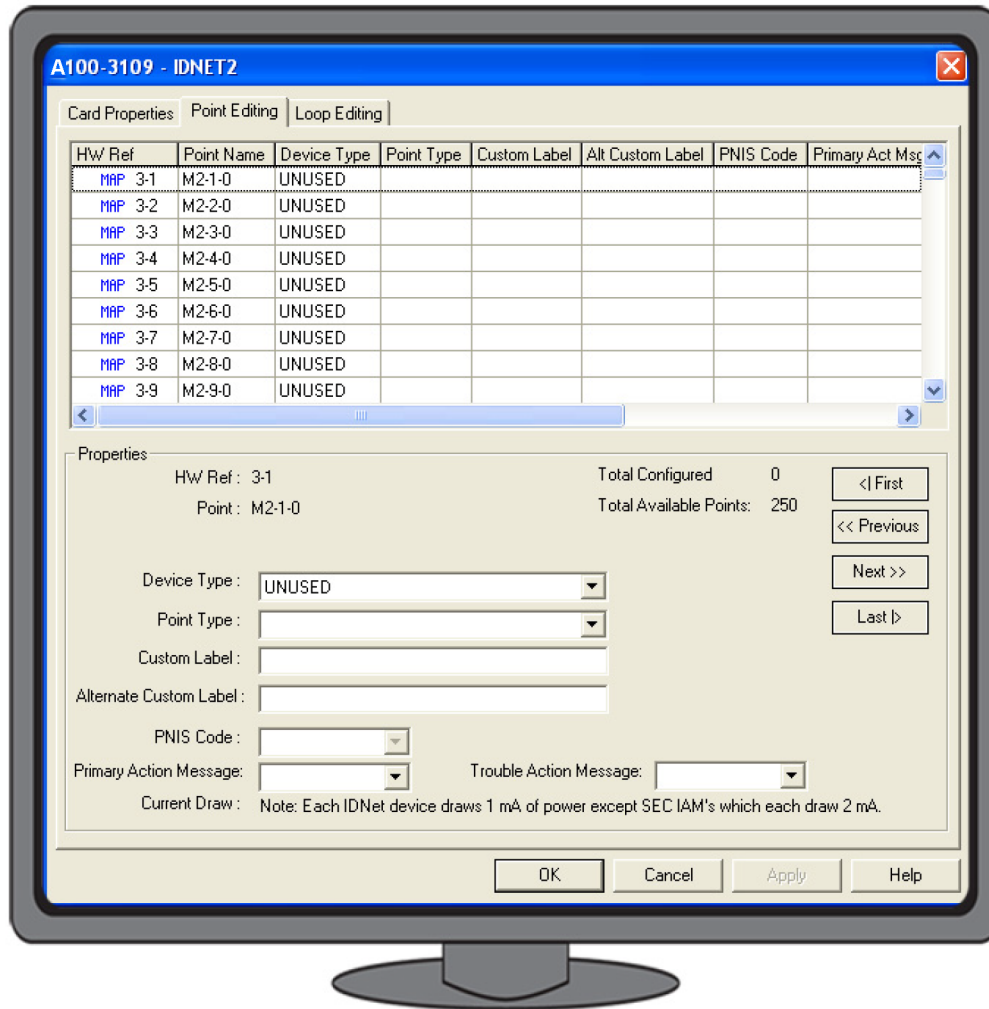

Figure 13: Point Editing Tab

Configuring the Loop Editing Tab

The Loop Editing tab determines the configuration of the loops.

When the IDNet 2 card is added to the ES Programmer, the programmer automatically reserves four specific addresses for the four potential loops.

- Loop 1: Point 251
- Loop 2: Point 252
- Loop 3: Point 253
- Loop 4: Point 254

The device type for both Loop 1 and Loop 2 is set to ISO and cannot be edited.

The device type for Loop 3 and Loop 4 is set to UNUSED by default and must be set to ISO for those loops to be activated.

Once the device type has been determined the following fields may be completed:

- Custom Label
- Alternate Custom Label
- Primary Action Message
- Trouble Action Message

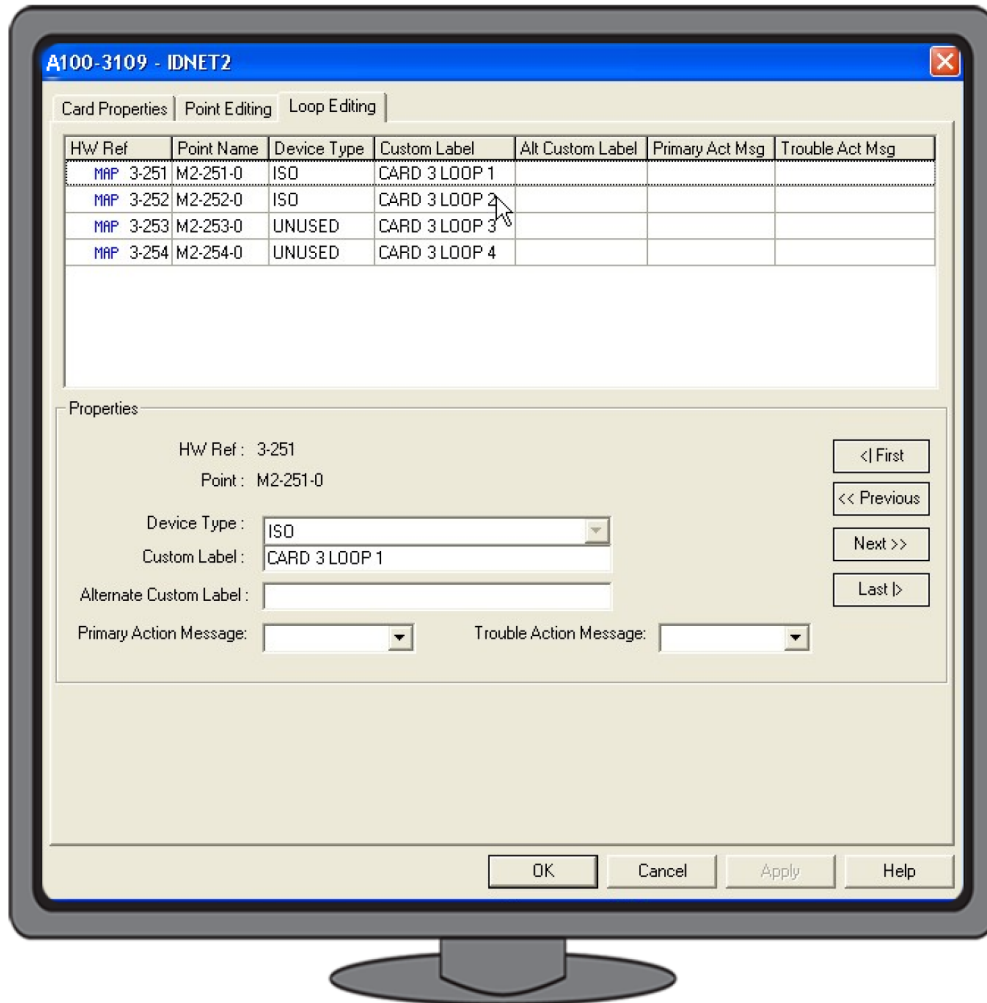

Figure 14: Loop Editing Tab

Troubleshooting

Troubleshooting

Refer to the tables below for a list of error messages that may appear on the FACP display when using the IDNet 2 card:

Table 3: Trouble Messages

Trouble Message	Possible Cause
Extra Device	<p>Appears if one or more extra devices (i.e., devices that have not been configured for the IDNet channel) are found on the system, or if a device is at an incorrect address.</p> <p>Note: An extra device on address 253 or 254 indicates that a Loop Module has been detected but not programmed.</p> <p>Only one trouble message appears, regardless of the number of extra devices found. Viewing the trouble log reveals the extra device address. Devices with LEDs will light their LED steady to indicate the trouble as long as no alarms are present in the system.</p>
Wrong Device	Appears when the device detected at the address does not match what is programmed in the system.
Earth Fault Search	Appears while the IDNet 2 card is searching for earth faults on the IDNet channel. When this message is displayed, the IDNet1+ card cannot show any alarms or other statuses.
Channel Fail	Appears when devices have been configured, but none of the devices are communicating on the channel. This message does not appear if there are no configured devices on the IDNet channel.
No Answer	<p>Appears when a device is missing, damaged, improperly configured, or duplicate devices are present.</p> <p>Note: A No Answer trouble on address 253 or 254 indicates a loop module has been programmed but not detected.</p>
Bad Answer	Appears when there is a faulty device, a noisy communications channel, or duplicate devices are present.

Table 3: Trouble Messages

Trouble Message	Possible Cause
Output Abnormal	Occurs during any of these conditions: <ul style="list-style-type: none"> • When 24 V is not present on IDNet devices (MBZAM and MAZAM devices for example). • When TrueAlarm sensor bases with relay driver outputs are not properly supervised. • When isolator devices are in isolation mode.
Note: Additional troubleshooting information about duplicate devices, weak answers and other problems may be obtained through panel diagnostics.	

Table 4: Loop Troubles

All loop statuses report on the isolator points (unlike the IDNet+ card where card status points are used to report the short and open statuses of the loops).

Supported Loop Statuses:	Loop Connected OFF Loop Isolated ON Break in loop wiring OPEN CKT TROUBLE Short circuit SHORT CKT TROUBLE
The isolator devices may be made Public to the network so that loop status is readily available at external nodes instead of reporting in the common trouble point. <ul style="list-style-type: none"> • If expansion loop cards are programmed but not connected, No Answer troubles are indicated for those devices. • If the loop card is present but not programmed, an Extra Device card status trouble is indicated for the card and the appropriate address (253, 254, or both) is logged in the trouble log. 	

Card Specifications

Card Specifications

Table 5: IDNet 2 Card Specifications

Operating Conditions:	
Operating Temperature Range	32°F - 120°F (0°C-49°C).
Operating Humidity Range	Up to 93% relative humidity at 90°F (32°C), non-condensing.
Electrical Specifications:	
Channel Voltage to Remote Devices	30 VDC (normal); 35 VDC maximum. During an alarm or when activating large quantity of device outputs, the channel output voltage is increased to 35 VDC. Data rate is 3333 bps. Output circuits are supervised and power-limited.
Earth Detection Threshold	10k ohms minimum from either positive or negative terminals.
Card Supply Requirements	24 V / 470 mA maximum. 100 mA for the first device, 0.8 mA for each additional IDNet device.
Comm Wiring Distance	See Table 2.

Table 6: IDNet Loop Card Specifications

Operating Conditions:	
Operating Temperature Range	32°F - 120°F (0°C-49°C).
Operating Humidity Range	Up to 93% relative humidity at 90°F (32°C), non-condensing.
Electrical Specifications:	
Channel Voltage to Remote Devices	30 VDC (normal); 35 VDC maximum. During an alarm or when activating large quantity of device outputs, the channel output voltage is increased to 35 VDC. Data rate is 3333 bps. Output circuits are supervised and power-limited.
Earth Detection Threshold	10k ohms minimum from either positive or negative terminals.
Card Supply Requirements	24 V.
Comm Wiring Distance	See Table 2.

