

## Cautions, Warnings, and Regulatory Information

**READ AND SAVE THESE INSTRUCTIONS** Follow the instructions in this installation manual. These instructions must be followed to avoid damage to this product and associated equipment. Product operation and reliability depend upon proper installation.



**DO NOT INSTALL ANY AUTOCALL™ PRODUCT THAT APPEARS DAMAGED** Upon unpacking your Autocall product, inspect the contents of the carton for shipping damage. If damage is apparent, immediately file a claim with the carrier and notify an authorized Autocall product supplier.



**ELECTRICAL HAZARD** Disconnect electrical field power when making any internal adjustments or repairs. All repairs should be performed by a representative or an authorized agent of your local Autocall product supplier.



**STATIC HAZARD** Static electricity can damage components. Handle as follows: Ground yourself before opening or installing components. Prior to installation, keep components wrapped in anti-static material at all times.

## Application Notes

The Wall variants are UL listed for General Signaling only but cannot be used in lieu of UL listed Notification Appliances in the area where they are listed. The Base variants are not suitable for evacuation notification usage.

## Introduction

The Addressable Sounder and Sounder Beacons operate with the 4100ES or 4010ES Fire Alarm Control Panels via their Loop Card's addressable loop but must not be used with unauthorised third-party equipment. They are available in ceiling and wall mounting variants including an outdoor wall version. The ceiling mounted variants provide a base for fitting an addressable Fire Detector. Alternatively a blanking cap should be fitted.

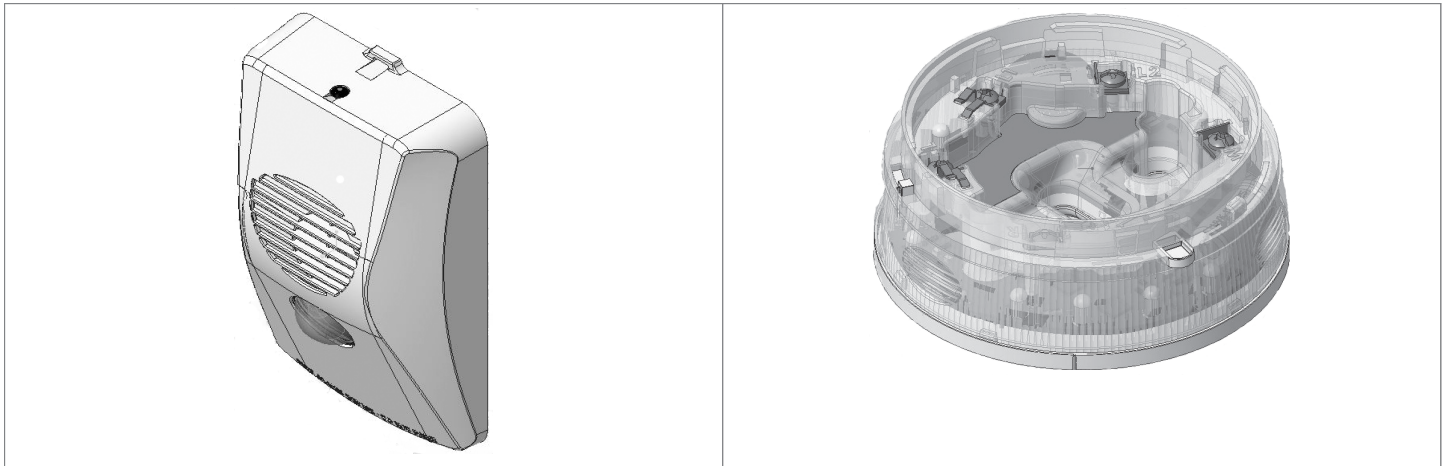

## Summary of the range

Product	Details
<b>Base variant</b>	
A4098-5217	Addressable Base Sounder
A4098-5220	Addressable Base Sounder Beacon
<b>Wall variant</b>	
A4906-5213	Addressable Wall Sounder Beacon White
A4906-5214	Addressable Wall Sounder Beacon Red
A4906-5215	Addressable Wall Sounder Beacon Weatherproof
<b>Accessories</b>	
A4905-5201	Blanking Cap for Sounder Bases
A4905-5202	Conduit Adaptor for Sounder Bases
A4905-5203	Shallow Surface Back Box for Indoor Wall Sounder Red
A4905-5204	Shallow Surface Back Box for Indoor Wall Sounder White
A4905-5205	Flush Backbox Adaptor for Indoor Wall Sounder



Product	Details
A4905-5206	Deep Surface Back Box for Indoor Wall Sounder Red
A4905-5207	Deep Surface Back Box for Indoor Wall Sounder White

## General Information

	A4098-5217	A4098-5220	A4906-5213	A4906-5214	A4906-5215
<b>Mounting orientation</b>	Ceiling		Wall		
<b>Indoor/Outdoor</b>	Indoor		Indoor		Outdoor
<b>Weight (g)</b>	146 g (5.15 oz)	154 g (5.4 oz)	194 g (6.8 oz)	194 g (6.8 oz)	372 g (13.1 oz)
<b>Operating temperature (°C)</b>	0°C to 70°C (-32°F to +158°F)		0°C to 49°C (-32°F to 120°F)		-25°C to +70°C (-13°F to +158°F)
<b>Storage temperature (°C)</b>	-25°C to +70°C (-13°F to +158°F)				
<b>Humidity</b>	Up to 95% non-condensing				
<b>Sounder volume settings</b>	4		2		
<b>Isolator</b>	Yes				
<b>Beacon flash rates</b>	-		0.5 Hz and 1 Hz		
<b>Typical Sounder output at 1 metre (3.28 feet)</b>					
<b>High volume</b>	90 dBA		100dBA		
<b>Mid High volume</b>	80 dBA		-		
<b>Mid Low volume</b>	70 dBA		-		
<b>Low volume</b>	60 dBA		90 dBA		

### Loop loading (A4098-525X series addressable detector fitted to the base variants)

Sounder volume	Beacon flash rate (if applicable)	Wall sounder beacon	Base sounder	Base sounder beacon
OFF	OFF	0.35 mA	0.88 mA	0.88 mA
LOW	OFF	3.2 mA	3.0 mA	3.0 mA
HIGH	OFF	8.6 mA	4.8 mA	4.8 mA
HIGH	0.5 Hz	11.2 mA	-	8.0 mA
HIGH	1 Hz	13.6 mA	-	9.6 mA

**Note:** Please refer to the loop loading calculator for these units.

## Address programming and configuration

Default address = 255. Set the address before installation using either the 801AP service tool with its ancillary lead. Remove the front cover to access the programming port on wall devices. The 850EMT tool can be used to set the tone, flash rate and volume level. Refer to the document 125.515.058: 850 Engineering Tool User Manual for details.

# Installation

## Dimensions

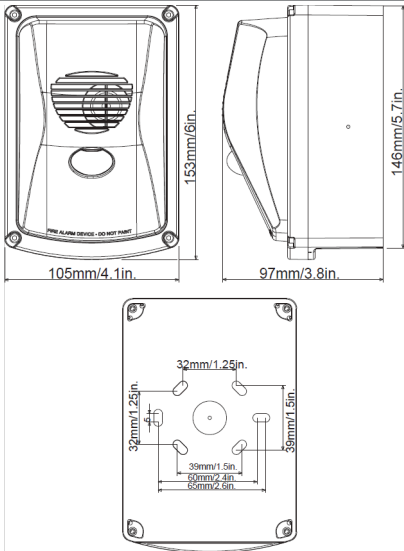
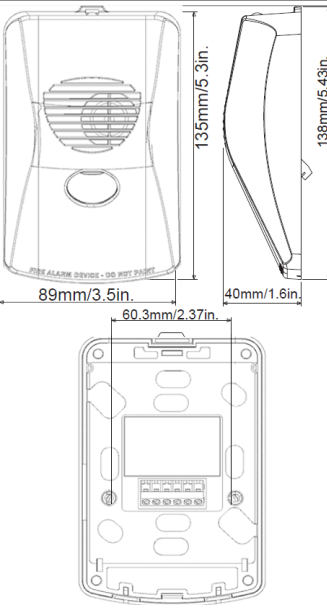
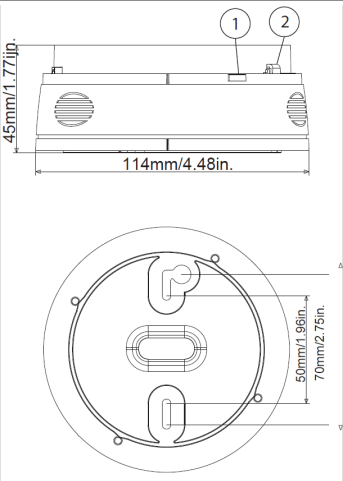
Weatherproof wall units	Indoor wall units	Base units
 <p><b>Figure 1: Sounder Beacon</b></p>	 <p><b>Figure 2: Sounder Beacon</b></p>	 <p><b>Figure 3: Base unit</b></p> <ol style="list-style-type: none"> <li>1. Temporary park plunger and indicator (yellow) for short circuit isolator.</li> <li>2. Address flag holder.</li> </ol>

## Wiring

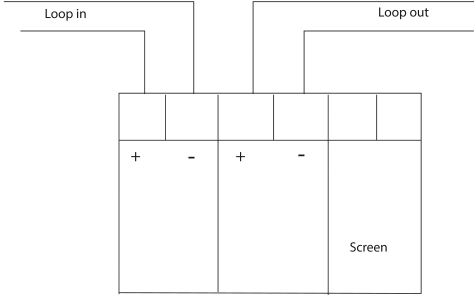
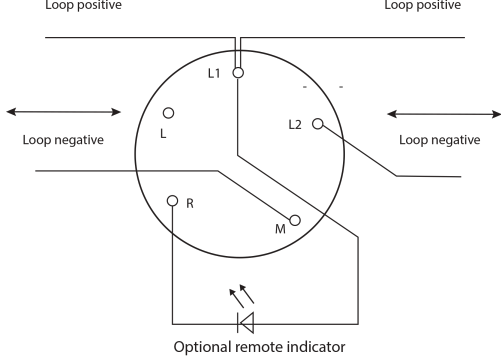
Wall variant wiring	Base variant wiring	Contact and Function
 <p data-bbox="228 669 516 699">Figure 4: Wall variant wiring</p>	 <p data-bbox="821 646 1114 676">Figure 5: Base variant wiring</p>	<p data-bbox="1268 275 1377 300">L: Not used</p> <p data-bbox="1268 306 1479 359">L1: Positive line in and out</p> <p data-bbox="1268 365 1455 420">L2: Negative line (isolator in and out)</p> <p data-bbox="1268 426 1500 478">M: Negative line (isolator in or out)</p> <p data-bbox="1268 485 1479 558">R: Remote LED out, wired only if a remote indicator is required.</p>

### Wiring notes

- All wiring must comply with local installation regulations and local fire system design requirements.
- Ensure all conductors are free of earths.
- Verify correct wiring and wiring polarity before connecting the devices to the addressable loop.
- Cables are to be selected in accordance with local standards, and with document 17A-02-D: MX Range of Addressable Controllers.

## Mounting and fixing instructions

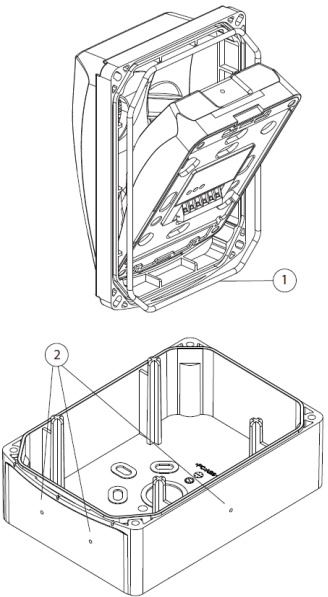
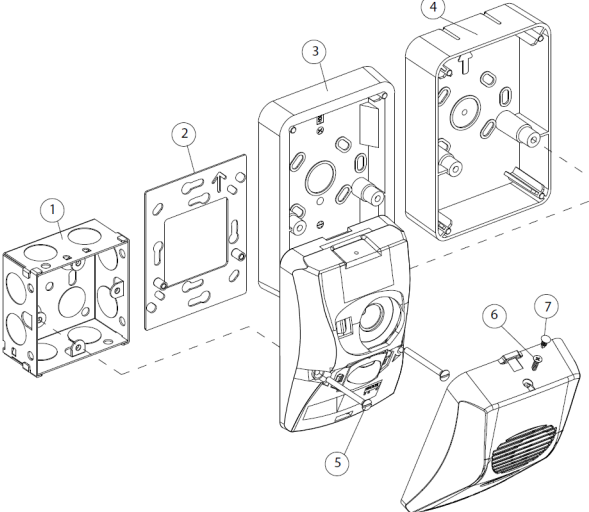
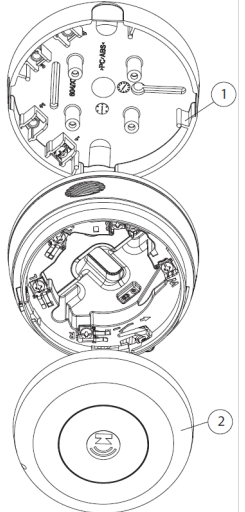
Weatherproof wall units	Indoor wall units	Base units
<p>These units are supplied with their own back box and special front cover. A sealing ring is supplied fitted on this front cover. See item 1 in Figure 6.</p> <ol style="list-style-type: none"> <li>1. Fix the back box to the wall. Drill positions for glands on the top, bottom, and sides, see item 2 in Figure 6.</li> <li>2. Slide the wall unit into place in the front cover as shown and then push down until it clips in.</li> <li>3. Secure the front cover (including the wall unit) to the back box with the four supplied screws (M3.5 hex head) using the supplied Allen key.</li> </ol> <p><b>Note:</b> To maintain the IP rating, use suitably rated cable glands and sealant as required.</p>	<ol style="list-style-type: none"> <li>1. Unclip the front cover from the wall unit using the screwdriver slot on the top. The front cover is hinged at the bottom of the unit.</li> <li>2. Use the two supplied screws to either fix the unit to the optional back box (with knockouts for conduit connections) or to the optional adaptor plate or to a back box with suitable mating fixings.</li> <li>3. Refit the front cover, engaging the clips on the bottom first.</li> <li>4. Secure the front cover with either the supplied self-tapping screw or nylon plug.</li> </ol> <p><b>Note:</b> If using the adaptor plate, a suitable recess is required for the connector block protruding from the rear of the wall unit.</p>	<p>These units either fit directly to the ceiling or to an optional ceiling adaptor. The ceiling mounted variants provide a base for fitting a fire detector. Alternatively, a blanking cap is fitted. See Figure 8. See Figure 10 for fitting the locking pin. To remove a detector from a base with a locking pin, complete these steps:</p> <ol style="list-style-type: none"> <li>1. Insert a suitable tool into the access hole to depress the locking pin in the detector cover.</li> <li>2. Rotate the detector to remove.</li> </ol> <p>These units can be used with the Ceiling Tile Adapter (CTA) kit (517.050.060) by using the CTA Adaptor Plate, CTA-AP (517.050.058). Use the knock outs for the cabling as required.</p>
 <p><b>Figure 6: Fitting weatherproof wall units</b></p>	 <p><b>Figure 7: Indoor wall units</b></p> <ol style="list-style-type: none"> <li>1. Single gang flush back box</li> <li>2. A-BOX</li> <li>3. S-BOX</li> <li>4. D-BOX</li> <li>5. M3.5 screw x 2</li> <li>6. Self-tapping screw</li> <li>7. Nylon plug</li> </ol>	 <p><b>Figure 8: Fitting base units</b></p> <ol style="list-style-type: none"> <li>1. A-CON</li> <li>2. B-CAP</li> </ol>

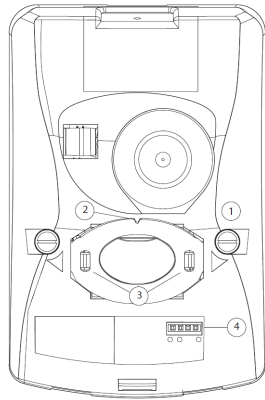
**Wall units**

**Figure 9: Checking the gasket**

1. Check that the gasket (item 1) is seated correctly before fitting the front cover.
2. Note the 'v' notch (item 2) on the upper side and gasket retained by the hooks on both sides (item 3).
3. Item 4 is the programming port.

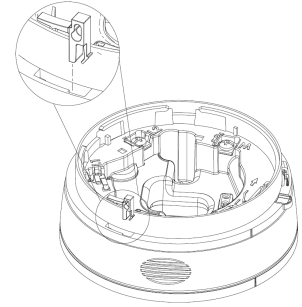
**Base units**

**Figure 10: Fitting the locking pin**